

LUMIÈRE CONFIGURATION I

LUMIÈRE DISPLAY - SETUP INSTRUCTIONS

SET UP INSTRUCTIONS

Set Up Pop Up Frame



a. Place frame with the adjustable feet facing down.

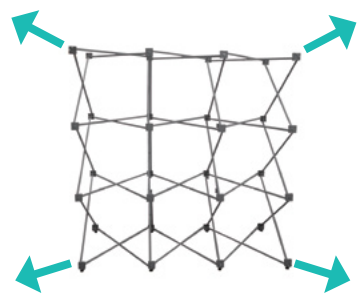

b. Expand the frame.

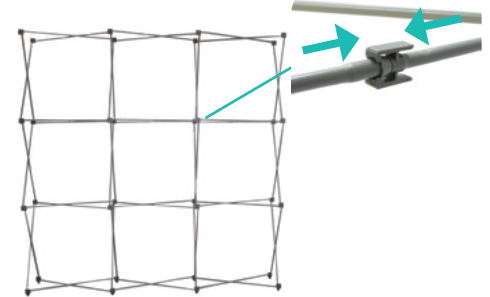

c. Close frame by pushing the outside of the frame until male and female ends connect.

Insert Channel Bars

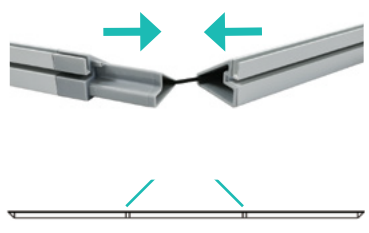

a. Expand each channel bar. Follow bungee to connect.

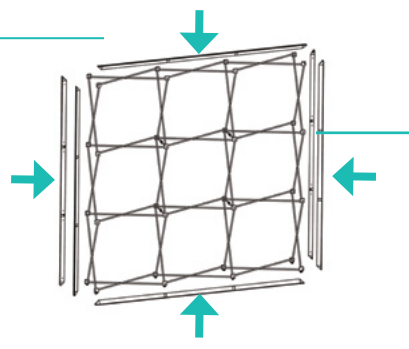

b. Attach channel bars to frame.



c. Slide channels bars onto frame, from top to bottom, then secure onto metal peg.



d. Attach the top and bottom end caps on each side of the frame.

Install Graphic



a. In each corner, insert the silicone edge beading into the groove.



b. Then insert the remainder of the beading.



c. Repeat graphic installation on the end caps.

Optional Accessories

Light Bracket:

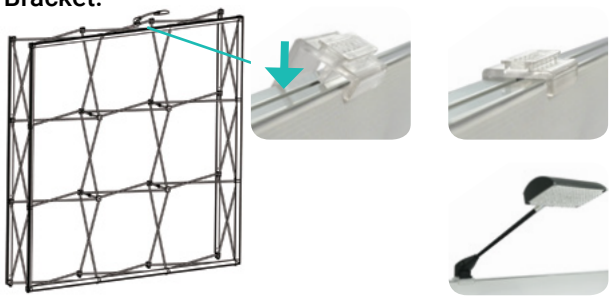

a. Snap the LED Light Bracket on top of the frame. Then slide the LED Light onto the bracket.

Stabilized Feet:

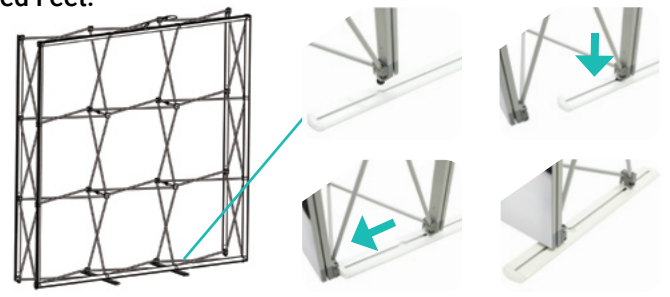

a. From the back, lift frame and insert adjustable feet onto stabilized feet. Then slide stabilized feet toward and insert onto the adjustable feet.

LUMIÈRE CONFIGURATION I

LUMIÈRE DISPLAY - SETUP INSTRUCTIONS

SET UP INSTRUCTIONS

(CONFIGURATION I)

Connecting Return Wall

Front View

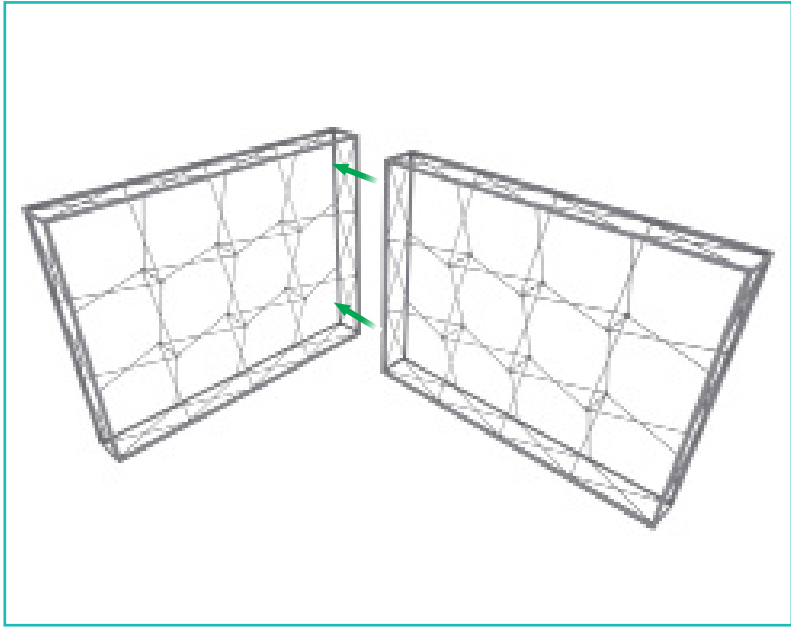

Back View

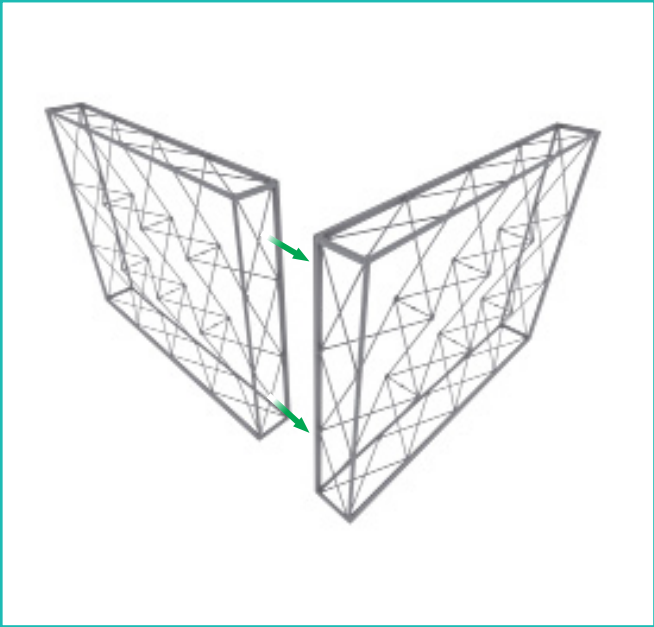

Adjoin the 10' x 7.5' frame perpendicular (90° angle) to the front side of the other 10' x 7.5' frame.

Note: Rendering shown without graphics for clarity. Graphics must be installed before connecting frames.

L Link Connection



Pull 10' x 7.5' graphic away to make space for L Connector.

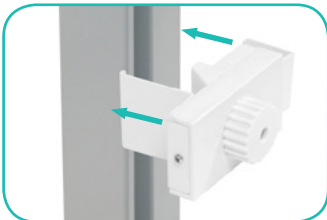

Slide L Connector onto adjacent channel bars (from both frames).

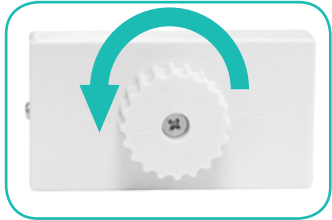

Turn dial to the left to lock the L Link Connector in place. Repeat for each vertical section.

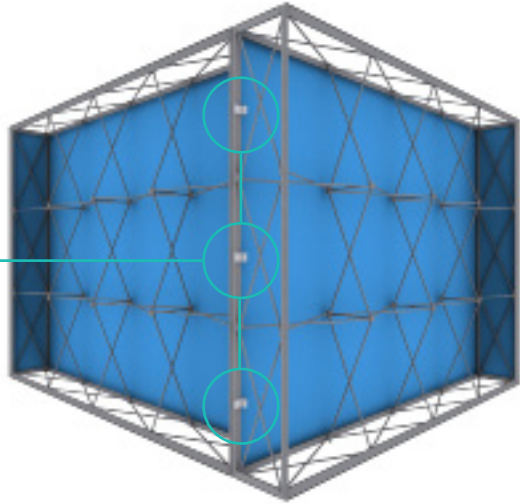

LUMIÈRE CONFIGURATION I

LUMIÈRE DISPLAY - SETUP INSTRUCTIONS

Step 1

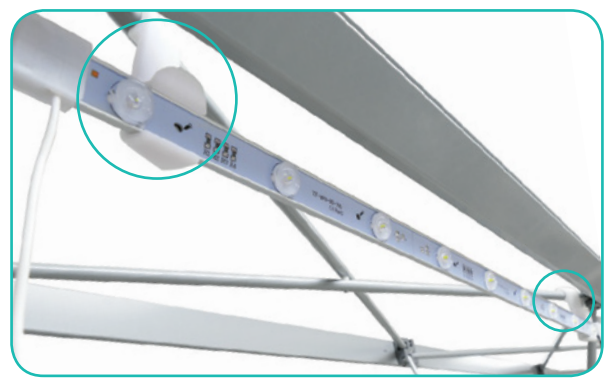

a. Hang ladder lights by placing the brackets on the top and bottom of the frame.

Step 2



b. Snap brackets onto the ladder lights on each side. Then place brackets on the top and bottom middle cross sections of the frame.

Step 3

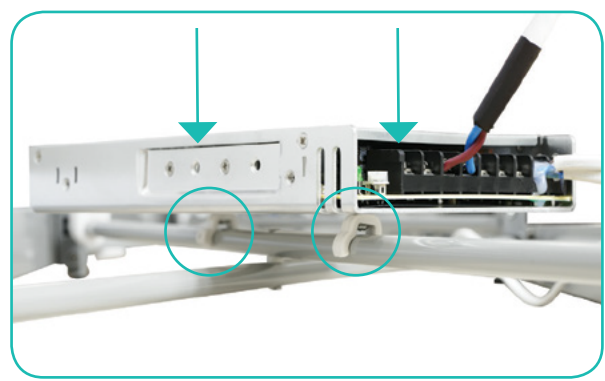

c. Place two transformers on the bottom of the frame by snapping onto each cross sections.

Step 4

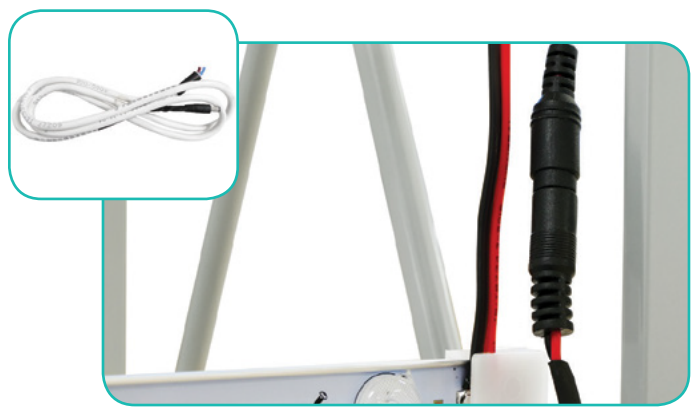

d. Connect transformer cord and ladder light cord together.

Step 5

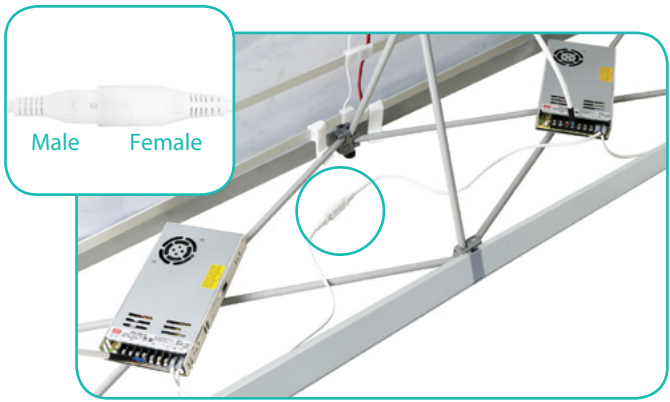

e. Plug each transformers together by connecting male and female connector cords.

Step 6

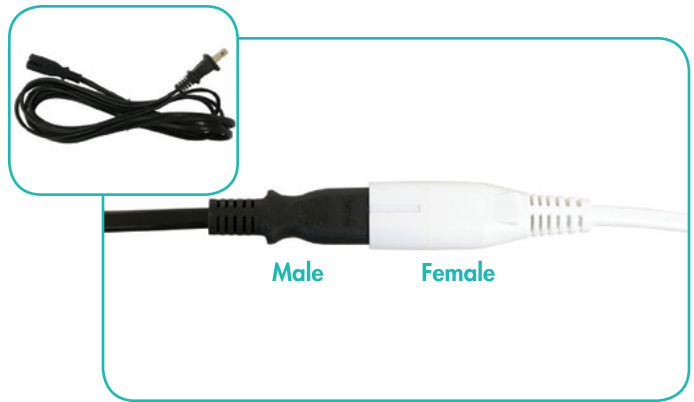

f. Then connect male power cord and female transformer connector cord together.